

TOSHIBA Photocoupler GaAs Ired & Photo-MOS FET

# TLP206G

PBX

Modem · FAX Card

Measurement Instrument

The TOSHIBA TLP206G consists of gallium arsenide infrared emitting diode optically coupled to a photo-MOS FET in a 8 pin SOP.

The TLP206G is a 2-Form-A switch which is suitable for replacement of mechanical relays in many application.

- SOP 8 pin (2.54SOP8): 2-Form-A
- Peak off-state voltage: 350V(min)
- Trigger LED current: 3mA(max)
- On-state current: 120mA(max)
- On-state resistance: 35Ω(max)
- Isolation voltage: 1500V<sub>rms</sub>(min)
- UL recognized: UL1577, file no.E67349
- BSI approved: BS EN60065: 1994,certificate no.8273  
BS EN60950: 1992,certificate no.8274
- SEMKO approved: SS EN60065  
SS EN60950
- Option(V4)type  
TUV approved: DIN VDE0884 / 06.92,  
certificate No. R9850580

Unit in mm

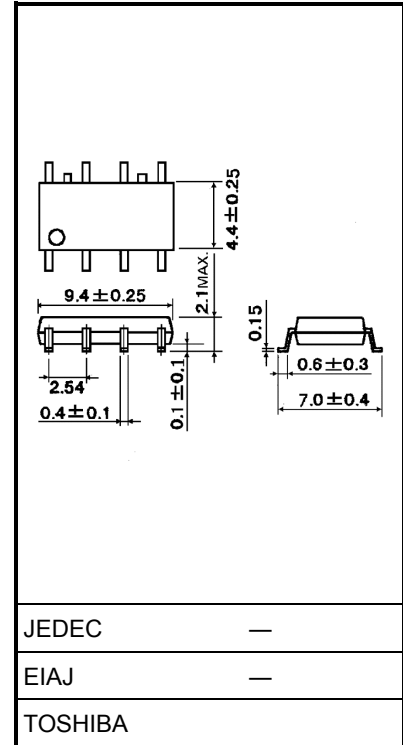

Weight: 0.2 g

## Schematic

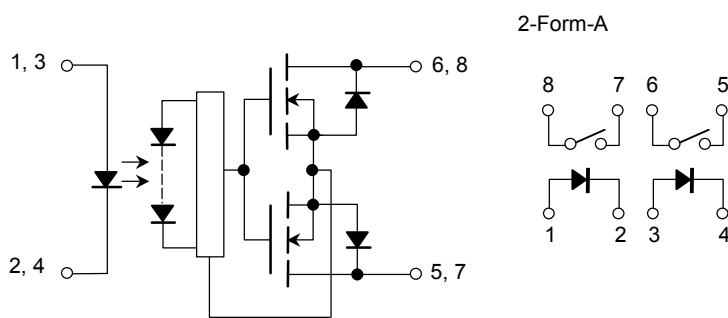

## Pin Configuration (top view)

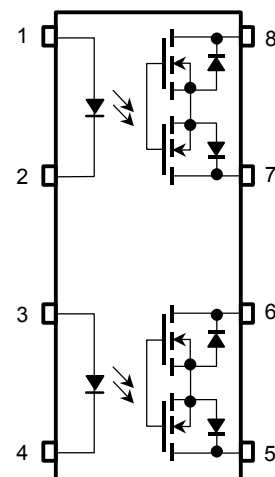

- 1, 3: Anode
- 2, 4: Cathode
- 5: Drain D1
- 6: Drain D2
- 7: Drain D3
- 8: Drain D4

## Maximum Ratings (Ta = 25°C)

Characteristic		Symbol	Rating	Unit	
LED	Forward current	$I_F$	50	mA	
	Forward current derating (Ta ≥ 25°C)	$\Delta I_F / ^\circ\text{C}$	-0.5	mA / °C	
	Pulse forward current (100μs pulse, 100pps)	$I_{FP}$	1	A	
	Reverse voltage	$V_R$	5	V	
	Junction temperature	$T_j$	125	°C	
Detector	Off-state output terminal voltage	$V_{OFF}$	350	V	
	On-state current	Both channel (Note 1)	$I_{ON}$	100	mA
		One channel		120	
	On-state RMS current derating (Ta ≥ 25°C)	Both channel (Note 1)	$\Delta I_{ON} / ^\circ\text{C}$	-1.0	mA / °C
		One channel		-1.2	
Junction temperature	$T_j$	125	°C		
Storage temperature range		$T_{stg}$	-55~125	°C	
Operating temperature range		$T_{opr}$	-40~85	°C	
Lead soldering temperature (10 s)		$T_{sol}$	260	°C	
Isolation voltage (AC, 1 min., R.H. ≤ 60%) (Note 2)		$BV_S$	1500	$V_{rms}$	

(Note 1): Two channels operating simultaneously.

(Note 2): Device considered a two-terminal device: Pins 1,2,3 and 4 shorted together and pins 5,6,7 and 8 shorted together.

## Recommended Operating Conditions

Characteristic	Symbol	Min.	Typ.	Max.	Unit
Supply voltage	$V_{DD}$	—	—	280	V
Forward current	$I_F$	5	7.5	25	mA
On-state current	$I_{ON}$	—	—	100	mA
Operating temperature	$T_{opr}$	-20	—	65	°C

## Individual Electrical Characteristics (Ta = 25°C)

Characteristic		Symbol	Test Condition	Min.	Typ.	Max.	Unit
LED	Forward voltage	$V_F$	$I_F = 10 \text{ mA}$	1.0	1.15	1.3	V
	Reverse current	$I_R$	$V_R = 5 \text{ V}$	—	—	10	$\mu\text{A}$
	Capacitance	$C_T$	$V = 0, f = 1 \text{ MHz}$	—	30	—	pF
Detector	Off-state current	$I_{OFF}$	$V_{OFF} = 350 \text{ V}$	—	—	1	$\mu\text{A}$
	Capacitance	$C_{OFF}$	$V = 0, f = 1 \text{ MHz}$	—	40	—	pF

## Coupled Electrical Characteristics (Ta = 25°C)

Characteristic	Symbol	Test Condition	Min.	Typ.	Max.	Unit
Trigger LED current	$I_{FT}$	$I_{ON} = 120 \text{ mA}$	—	1	3	mA
On-state resistance	$R_{ON}$	$I_{ON} = 120 \text{ mA}, I_F = 5 \text{ mA}$	—	22	35	$\Omega$

## Isolation Characteristics (Ta = 25°C)

Characteristic	Symbol	Test Condition	Min.	Typ.	Max.	Unit
Capacitance input to output	$C_S$	$V_S = 0, f = 1 \text{ MHz}$	—	0.8	—	pF
Isolation resistance	$R_S$	$V_S = 500 \text{ V}, \text{R.H.} \leq 60\%$	$5 \times 10^{10}$	$10^{14}$	—	$\Omega$
Isolation voltage	$BV_S$	AC, 1 minute	1500	—	—	$V_{rms}$
		AC, 1 second, in oil	—	3000	—	
		DC, 1 minute, in oil	—	3000	—	$V_{dc}$

## Switching Characteristics (Ta = 25°C)

Characteristic	Symbol	Test Condition	Min.	Typ.	Max.	Unit
Turn-on time	$t_{ON}$	$R_L = 200 \Omega$ (Note 3) $V_{DD} = 20 \text{ V}, I_F = 5 \text{ mA}$	—	0.3	1	ms
Turn-off time	$t_{OFF}$		—	0.1	1	

(Note 3): Switching time test circuit

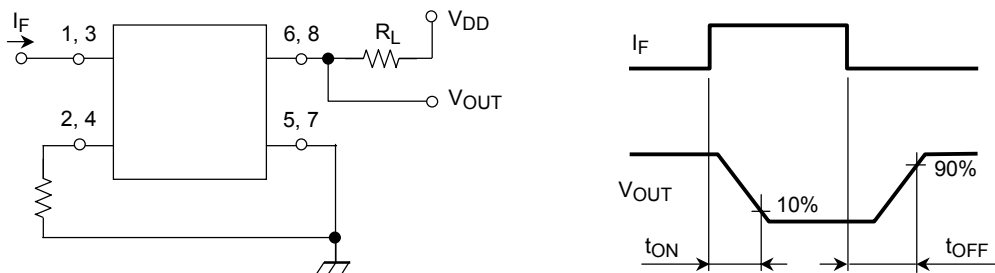

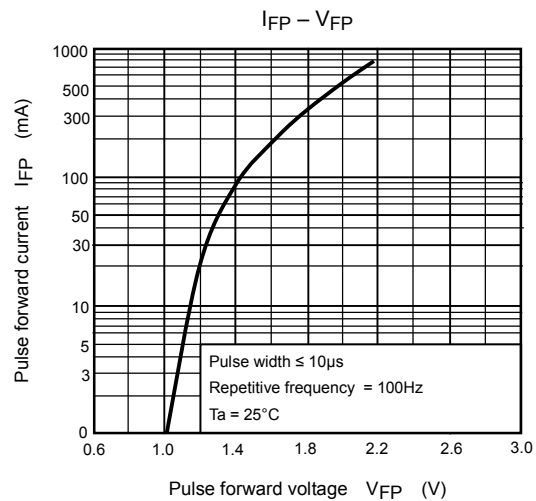
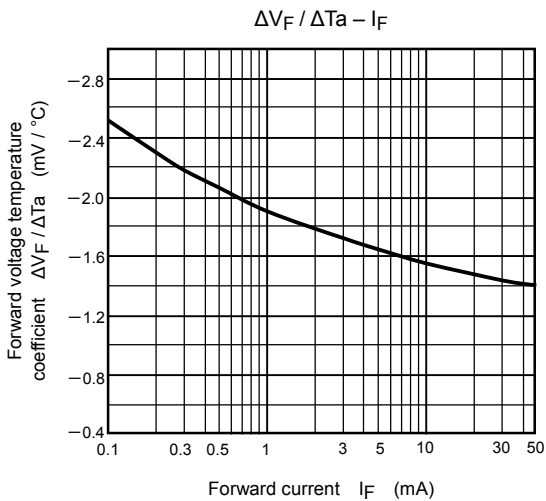
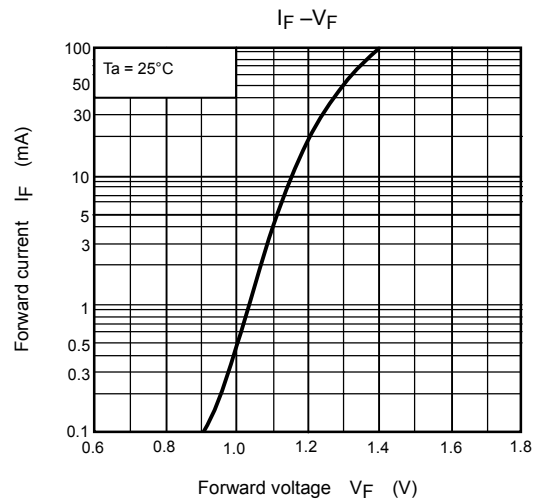
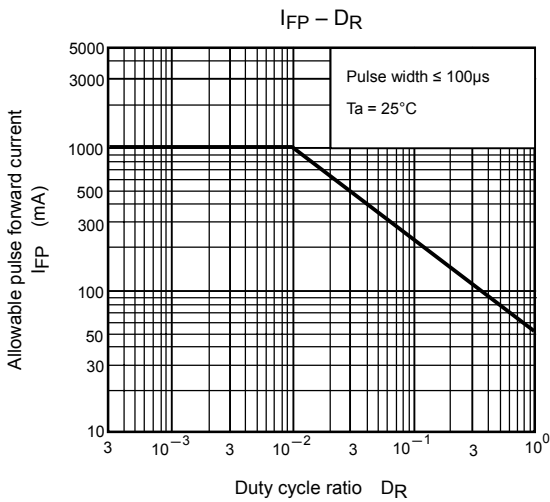
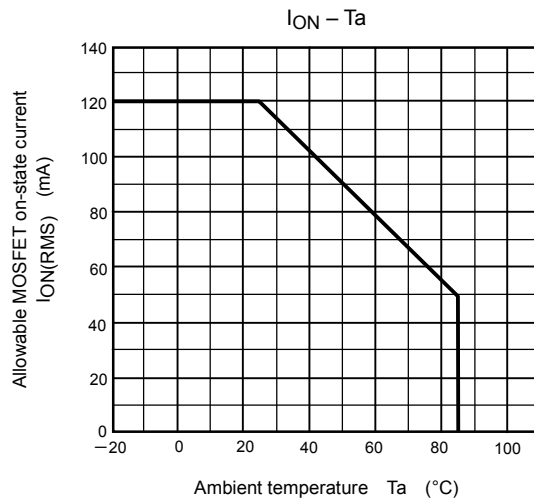
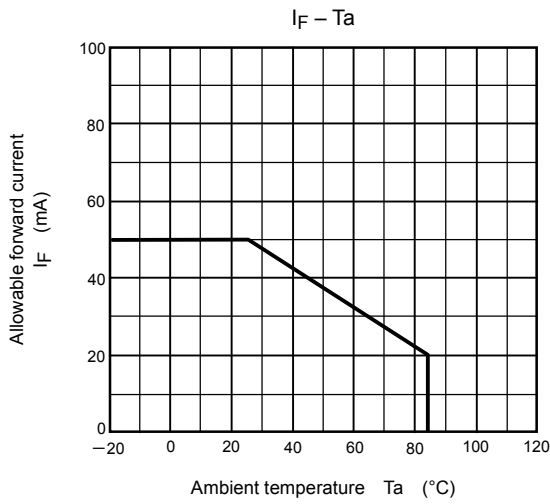

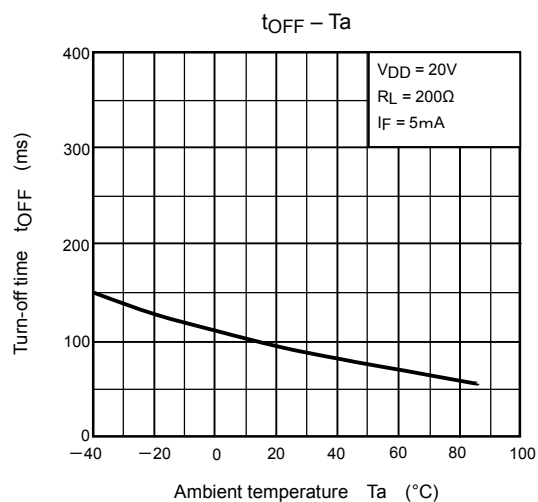
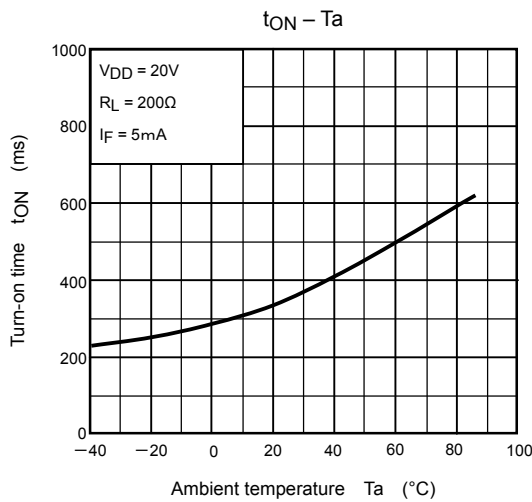
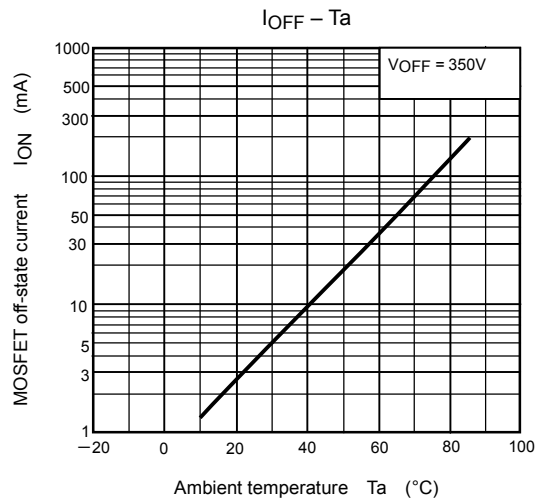
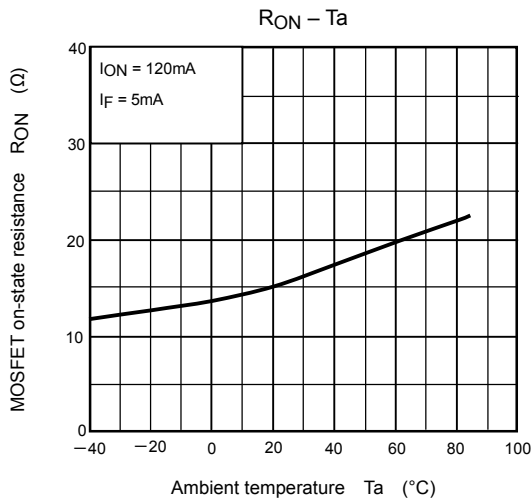
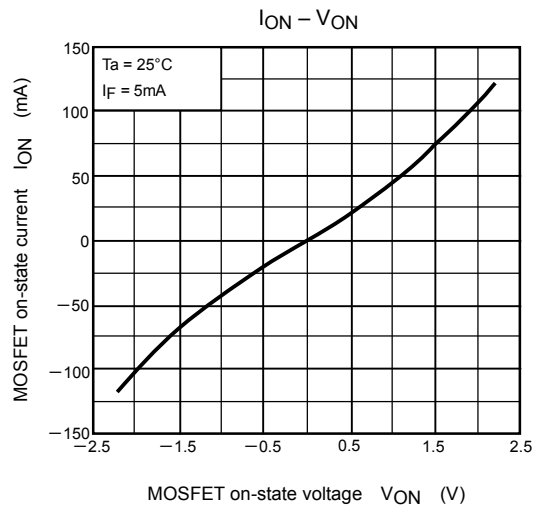
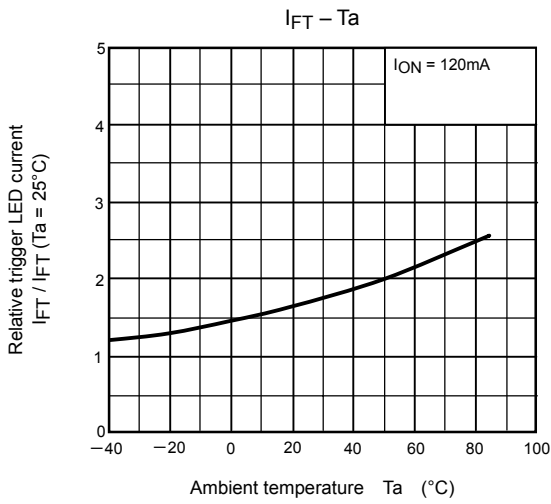

**RESTRICTIONS ON PRODUCT USE**

000707EBC

- TOSHIBA is continually working to improve the quality and reliability of its products. Nevertheless, semiconductor devices in general can malfunction or fail due to their inherent electrical sensitivity and vulnerability to physical stress. It is the responsibility of the buyer, when utilizing TOSHIBA products, to comply with the standards of safety in making a safe design for the entire system, and to avoid situations in which a malfunction or failure of such TOSHIBA products could cause loss of human life, bodily injury or damage to property.  
In developing your designs, please ensure that TOSHIBA products are used within specified operating ranges as set forth in the most recent TOSHIBA products specifications. Also, please keep in mind the precautions and conditions set forth in the "Handling Guide for Semiconductor Devices," or "TOSHIBA Semiconductor Reliability Handbook" etc..
- The TOSHIBA products listed in this document are intended for usage in general electronics applications (computer, personal equipment, office equipment, measuring equipment, industrial robotics, domestic appliances, etc.). These TOSHIBA products are neither intended nor warranted for usage in equipment that requires extraordinarily high quality and/or reliability or a malfunction or failure of which may cause loss of human life or bodily injury ("Unintended Usage"). Unintended Usage include atomic energy control instruments, airplane or spaceship instruments, transportation instruments, traffic signal instruments, combustion control instruments, medical instruments, all types of safety devices, etc.. Unintended Usage of TOSHIBA products listed in this document shall be made at the customer's own risk.
- Gallium arsenide (GaAs) is a substance used in the products described in this document. GaAs dust and fumes are toxic. Do not break, cut or pulverize the product, or use chemicals to dissolve them. When disposing of the products, follow the appropriate regulations. Do not dispose of the products with other industrial waste or with domestic garbage.
- The products described in this document are subject to the foreign exchange and foreign trade laws.
- The information contained herein is presented only as a guide for the applications of our products. No responsibility is assumed by TOSHIBA CORPORATION for any infringements of intellectual property or other rights of the third parties which may result from its use. No license is granted by implication or otherwise under any intellectual property or other rights of TOSHIBA CORPORATION or others.
- The information contained herein is subject to change without notice.